

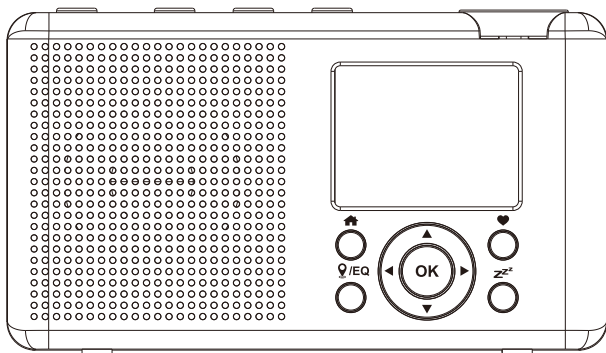

Portable Internet Radio with DAB+/DAB and FM

WR-23D

User Manual



Please read this user manual carefully before using the receiver



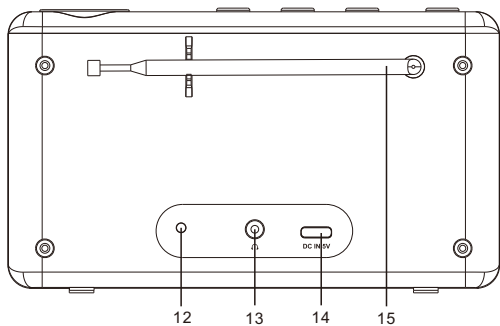
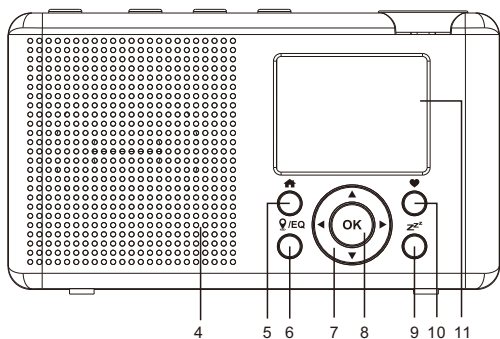
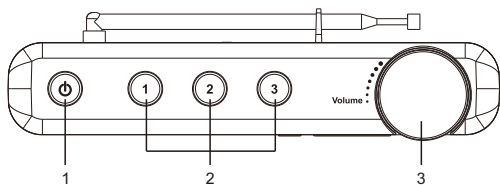

Contents

Location of Controls	1
How to input password for your wireless network	3
1. Getting started	5
2. Charging battery	6
3. Network Setup	7
4. Overview of features and functions	9
5. Internet Radio	10
6. Media Centre	13
7. DAB+/DAB Radio	15
8. FM Radio	16
9. Bluetooth playback	18
10. Sleep Timer Setting	19
11. Configuration	20
12. Remote control via PC / Smart phone	
- Tuning internet radio & manage favourite	27
13. Trouble Shooting	30
Helpful Tips	32
Technical Specification	34
In the box	35

Location of Controls



Location of Controls

1.  Press and hold to power on/off
2. **Preset button 1-3**
Preset the top three favourite stations
Press and hold to preset
Press it briefly to recall
3. **Volume-/+**
Rotate to adjust the volume level
4. **Speaker**
5.  Access Home screen/press this button to return to the playing screen
6.  /EQ
Press the button to access local stations via internet.
Press and hold to enter the EQ setting menu.
7. **Navigation control (▲ ▼ ◀ ▶)**
[▶]
Right pointer/Enter edit menu of the Favourite list/
Display the big time clock & radio info on the now playing screen
[◀]
Back to previous menu/left pointer
[▲/▼]
Up and down pointer, scroll up/down on the list/menu
8. **OK**
9.  Set the timer to turn the radio off after a period of time.
10.  Press and hold to preset a particular station
Press to recall the favourite list
11. **TFT color screen 2.4"**
12. **LED indicator for battery charging status**
13. **Earphone jack 3.5 mm**
14. **USB-C port**
Recharge the built-in battery by connecting the USB type C cable
15. **Telescopic antenna**

How to input password for your wireless network

Use the [**▲/▼**] button to scroll through the characters, highlight it and press [**OK**] button to confirm and input the next character. When it comes to the last character of the password , press and hold the [**OK**] button to confirm and complete the entry.

Note: The password is case sensitive.

Please ensure the following is ready:

You have a broadband internet connection.

A wireless broadband router is connected to the internet successfully. The radio supports Wireless B, G and N connection (Wireless N router can also be used with the setting on B or G). You know the Wired Equivalent Privacy (WEP) or Wi-Fi Protected Access (WPA) data encryption code/password. You need to key in the correct code when the radio is connected to the wireless router for network connection. If you do not know the code/password, please contact the person/technician who set up the router/network for you.

The radio works via Wireless network connection (Wi-Fi connection).

Precautions

The radio should not be used in a high temperature or high humidity environment over prolonged periods of time as this may damage the unit.

Keep the radio away from liquids as it may get damaged. Please switch off the radio immediately if water or liquids is spilled into the radio. Consult with the shop you bought this radio for any question.

Avoid using or storing the unit in dusty or sandy environment. Do not open and repair the radio by yourself. Clean only with dry cloth.

1. Getting started

The radio is powered by the built-in lithium battery. A USB cable is supplied in the product package.

Press and hold the [] button to power on.

To power off the radio, press and hold the same button.

2. Charging battery

You can check the level of battery power remains on the radio.

There is a battery power indicator  showing on the top row of the screen.

When battery power is low, the battery indicator keeps blinking as a reminder for battery charging.

To charge the battery, connect the USB-C plug to the port where located at the rear side of the radio, connect the other end to a power source supplied in 5V OUT (the rating of the electric current is minimum 1A or higher). The LED on the rear side of the radio will light up in red indicates the battery is charging. The charging icon  will appear on the screen.

When charging is done, the LED on the rear side will turn to green and the icon on screen will change to . It means the radio has the power connected.

Note: The charging might take much longer to complete if the radio is playing while charging.

3. Network Setup

Internet connection is setup via Wireless network (WiFi). Your radio requires a broadband Internet connection.

- If this is first time use, the Configure Network wizard will be displayed. Choose Yes to start configuring network. Press the [◀] button to highlight Yes and press [OK] to confirm.

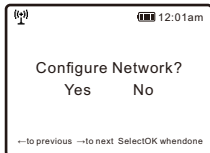

- Select Add/Remove AP from the list, use the navigation control buttons to scroll and press **OK** to confirm, then choose Add AP (Scan):

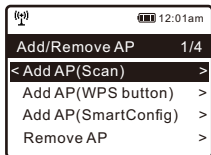
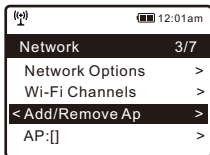

- It will start scanning the Wi-Fi networks available. Scroll to your network and press [OK] to confirm. If your wifi network has a password protected, it will ask you to enter the passphrase/password. Please refer to the above section '**How to input password for your wireless network**' on P.3.

Note: The password is case sensitive. Please consult with the one who setup your network if you don't know the password.

3. Network Setup

- When the Wi-Fi connection is successful, the Association Complete will be shown briefly. The wifi signal bar will appear on the top left corner of the display:

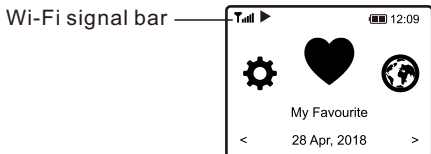

4. Overview of features and functions

Press [] to enter the Home screen. Scroll by using the navigation control buttons:

My Favorite - To show the list of favorite stations which have been assigned to the presets. There are up to 99 presets available.

Internet Radio - Start exploring the worldwide radio stations and music here.

Media Centre - Browse and stream music from your network via UPnP or DLNA Compatible devices.

DAB+/DAB Radio - Pick up DAB+ and DAB radio signal if available in your local area (no internet connection required).

FM Radio - Receive ordinary FM radio stations in your local area (no internet connection required).

Bluetooth - Bluetooth playback, to play audio stream (receive) from another Bluetooth enabled device after pairing/connected each other.

Sleep Timer - Enable the timer to turn the radio off after the selected time elapsed.

Configuration - More options/settings available to personalize as you desire.

5. Internet Radio

On the Home screen, choose **Internet Radio** and you will find the options below:

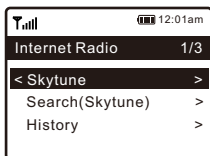

Skytune

Select Skytune to start enjoying thousands of radio stations over the world. You can filter your search by Region, Music genre and talks.

The **Local Radio** let you access quickly the stations available in your local area through internet connection.

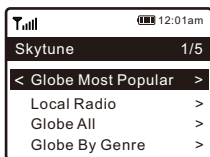

Note - You can change the Local Radio area under **Configuration> Local radio setup**. Please refer to section 10 for the details.

Search

Instead of browsing the radio station list, you can input a few characters of the desired station to filter out / short list the stations.

History

The radio memorizes the stations you have listened up to 99 stations.

If you have listened more than 99 stations, it will supersede the first station that you have listened.

5. Internet Radio

Start playing internet radio

When a radio station starts playing, more radio information can be displayed. Press the ► button when the screen shows the state of radio playback:

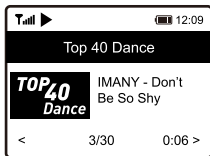

Every time you press the ► button, it will cycle through the information of the radio, the big time clock and the radio station logo if any.

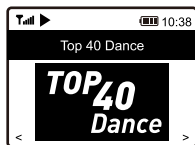
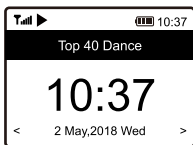

My Favorite

This is to show the list of your Favorite stations which have been assigned to the presets.

Preset a station

When the screen shows the state of radio playback, press and hold the ♥ button, you will see the ⏴ icon appeared as below. It means the station is added to the Favorite list.

5. Internet Radio

Preset icon



The new added station will always show in the last item on the Favorite list. You can store up to 99 presets. There are 3 dedicated preset buttons to quickly access the top 3 favourite station. Press and hold the numeric button on the radio unit to preset the channel.

Recall a station

Press the ♥ briefly on the radio to recall the list of presets, or navigate to **My Favourite** on the home screen and select it to confirm.

Edit your favorite list

On the Favorite list, choose the radio station you want to edit then press the [►] button. It will enter the Edit menu with the following options:

Move down - To move down the ranking of a station

Move up - To move up the ranking of a station

Delete - To delete a particular station

Move to top - To move the station to the top of the favorite list.

Move to bottom - To move the station to the bottom of the favorite list.

6. Media Centre

The device supports UPnP and is DLNA-compatible. This provides the opportunity to stream music from your network. However, this requires you to have a compatible device in your network that can function as a server. This can be e.g., a network hard drive or a conventional PC with e.g., Windows 8 via which access to the shared folder or media sharing is permitted. The folders can then be browsed and played on the radio.

Note - Please make sure your computer laptop is on the same Wi-Fi network as the Radio before you start using this function.

Music streaming

- Once the UPnP/DLNA compatible server is configured to share media files with your radio, you can start music streaming.
- On the main menu, select **Media Centre and choose UPnP**.
- It may take a few seconds for the radio to complete the scan for available UPnP servers. If no UPnP servers are found, it will show **Empty List**.
- After a successful scan is done, select your UPnP server.
- The radio will show the media categories available from the UPnP server, e.g. 'Music', 'Playlists' etc.
- Choose the media files that you wish to play.

You can set the mode of playback under **Configuration > Playback setup**.

My Playlist

You can make your own playlist for the UPnP music files. Choose and highlight the song you want to add to playlist, press and hold the **[OK]** button, until the sign  appeared. The song will be added to **My playlist**.

Clear My Playlist

Remove all songs in “My Playlist” to allow a new playlist to be prepared.

Note - If you have DLNA compatible servers available, follow the steps described above to browse the audio files from DLNA compatible device on the radio to play.

7. DAB+/DAB Radio

If there is Digital Audio Broadcasting (DAB) in your area, the Radio can pick up the DAB stations as well (no internet connection is required). The Radio supports both DAB and DAB+.

Place the Radio close to the window and extend the antenna as far as it can go to get the best reception. Sometimes you may need to adjust the direction of the antenna to improve reception.

On the Home screen, scroll to **DAB Radio**. Press **[OK]** to start.

It will ask whether you want to **Scan DAB Station**. Press **OK** to start scanning and it will show the progress on the number of channels received. When it is done, a preset page will be displayed for your action.

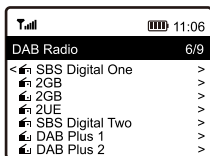

You can select the channel and start listening to it. Whenever you want to add to My Favourite, press and hold the **♥** button on the unit, and it will add to the favourite list.

Always press the **[◀]** button to return to the Preset list.

Note - When the screen shows the state of radio playback, press the **[▶]** button to view more radio information, each time you press the **[▶]** button, it will display various information at a time such as radio frequency, rolling texts (if available) and big time clock.

New digital radio stations should be picked up automatically by the radio if they are part of a multiplex you already received. Otherwise you need to do the Preset Scan again.

8. FM Radio

To receive the ordinary FM stations (no internet connection is required), place the radio close to the window and extend the antenna as far as it can go to get the best reception. Sometimes you may need to adjust the direction of the antenna to improve reception.

On the Home screen, scroll to FM Radio. Press **[OK]** to start.

It will ask whether you want to Scan FM Station. Press **OK** to start scanning and it will show the progress on the number of channels are found. When it is done, it will automatically save the found channels on presets and display the list for your action.

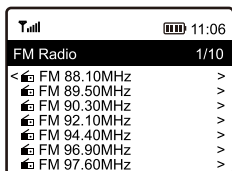

You can select the channel and start listening to it. Whenever you want to add to **My Favourite**, press and hold the **♥** button on the radio, and it will add to the favourite list.

Always press the **[◀]** button to return to the Preset list. Note - When the screen shows the state of radio playback, press the **[▶]** button to view more radio information, each time you press the **[▶]** button, it will display various information at a time such as radio frequency and big clock display.

8. FM Radio

Manual Tune

To manual tune the frequency, long press the **[OK]** button, until you see the **"Tuning"** appeared on the display, at the bottom right corner. Use the **<◀ / ▶>** button to tune the frequency. When done, long press the **[OK]** button to exit manual tune.

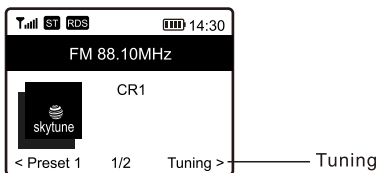

9. Bluetooth playback

Before transmission between your Bluetooth device and the radio is possible, both devices must be coupled. This process is called "pairing". The radio is served as a receiver, to receive music stream to play on the radio.

If you have already coupled to a Bluetooth device before, this connection will be restored automatically when both devices are in range and Bluetooth operation has been selected on the radio. "Pairing" does not have to be repeated. This function may need to be activated in your Bluetooth device, however.

- Push the Menu button to display the selection menu for the different operating modes.
- Use the up/down button to select the operating mode Bluetooth and push the dial switch.
- Switch your Bluetooth device to which you want to connect the radio on and activate the pairing mode here. The device scans for Bluetooth devices in the reception range.
- When the radio is found, your bluetooth device shows its name WR-23D-XXXX (the XXXX is an identification code for your radio unit).
- Select the radio at your bluetooth device.
- Start playback on your bluetooth device.
- Playback now takes place using the radio.

10. Sleep Timer Setting

Set the timer to turn the radio off after the selected time elapsed in the range of 15 minutes to 180 minutes.

Press [**Z**] button to set the timer.

You will see the icon appeared on the display if the timer is set.

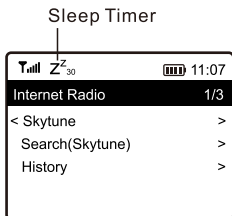

11. Configuration

Here you will find the complete settings / options available to configure your own radio. On the Home screen, navigate to Configuration setting. Press OK and you will see a list of options available.

Network

• Network Options

Always on: The WLAN function remains switched on (faster access when switching from other modes of radio).

Auto off in 30s: The WLAN function shuts down after 30 seconds when not in use (to save energy).

• Wi-Fi Channels

Not all of the Wi-Fi channels are available in every country. There may be variation between different countries. Therefore it is necessary to choose the Wi-Fi channels to ensure the Wi-Fi performs satisfactorily. We have already set the channels according to the requirement in different countries. Choose the country you are staying from the list to get the correct channel.

• Add / Remove AP

Add AP - It will scan out a list of WiFi networks around.

Add AP (WPS button) - Choose this option to connect your Wi-Fi router via WPS if the router has a WPS button.

Add AP (SmartConfig) - Choose this option to configure the W-Fi network with a smart phone through an app. It is available on iOS App Store and android play store. Search and install the app "EspTouch".



11. Configuration

Have your smart phone connected to the Wi-Fi network which the radio will be connected to.

It is recommended to place the radio within 2 meters from the router for better successful rate.

Follow the steps below:

1. On the radio, navigate to Configuration > Network > Add/Remove AP > Add AP (SmartConfig), press OK to confirm
2. Launch the App on your smart phone
3. The name of of the SSID (your Wi-Fi network) will show up as follow:

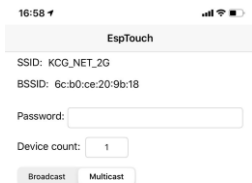

4. Enter the password of your network.
5. Tap "Multicast" followed by "Confirm" to complete.



11. Configuration

6. The radio will start associating with the network and followed with the message "Association complete" if network is successfully connected.

Remove AP - If you have already added a router and want to remove it, choose this option.

Note - Always place the radio within 2 meters of the Wi-Fi router for setup.

- **AP: []**

If you have added more than one routers on the radio and want to switch to another one, select this option to change.

- **Signal**

This is to show the strength of the Wi-Fi Signal of the Wi-Fi router as received by the radio. Usually signal levels lower than -70dBm is at weaker level and if it affects the reception of your radio, you may need to optimize the router location or check any problem of the router itself.

- **IP**

The IP is set Dynamic by default. Select to change Fixed IP according to your network condition.

- **DNS**

The DNS is set Dynamic by default. Select to change <Fixed> DNS according to your network condition.

Date and Time

The radio will set your local time automatically after the internet connection is completed. If you want to do manual setting, change it by the following options:

- **Time zone**

Auto-set Time Zone: This option is set by default.

11. Configuration

Manual-set Time Zone: Choose this option if you want to set the time in another region. Choose and highlight the region/city you prefer and press OK to confirm.

Coupled with NTP (use network time) and DST (Daylight time saving) will be adjusted automatically if you choose to use network time (NTP).

- **Set Time Format**

Choose either 12-hour or 24-hour notation you prefer.

- **Set Date Format**

- **DST (Day Light Saving)**

Enable on/off

- **NTP (Use network time)**

NTP is designed to synchronize a device's clock with a time server. Your radio will synchronize the time server by default every time it powers up and connects to Internet. This ensures a very high degree of accuracy in the radio's clock. You can change to use other time server by inputting the URL address (see below NTP server). You can choose "Do not use network time" if you don't want it to.

If you choose not to use NTP for clock synchronization, highlight the NTP (Network time protocol) and press OK to make the change. You will see the Set Date & Time appeared on the menu. Select it and adjust the date and time as you desire.

• **NTP Server**

NTP is designed to synchronize a device's clock with a time server. Here it shows the server being used for the radio.

Language

The default language is English, you can choose other languages as preferred. Scroll with the ▲▼ buttons to the item with  and press **OK**. Scroll to highlight and press **OK** to select your language of choice. English, French, Spanish, Italian, German, Dutch, Polish, Russian and Simplified Chinese are available.

Local Radio

The radio is set by default to detect the radio stations in your local area automatically through internet connection and these stations can be accessed by a press of [] button (Local). You can also set **Local** in another region if you want. Highlight the Local Radio and press **OK**. Choose **Manual-set Local radio** to change the region setting.

Playback Setup

This is to set the mode of playback under UPnP/DLNA compatible streaming: Repeat All, Repeat Once or Shuffle.

Resume Play Options

• **Resume once ready**

This is set by default. The radio will resume playing the last played station when it is power on the next time.

11. Configuration

• **Stay at home**

Choose this option if you want the radio to stay on the Home screen without playing anything when it is power on the next time.

Dimmer

You can set the backlight level for the display as you prefer. There are two settings: Mode and Level

• **Mode - Normal or Power Saving**

Normal - the display will stay with the same level of brightness all the time without dim down.

Dim - the display will dim down after 20 seconds if no operation is made on the radio.

• **Level - Bright and Dim**

Bright - This is to adjust the level of brightness in Normal mode.

Dim - This is to adjust the level of brightness in Dim mode.

EQ(Equaliser)

Various music genres can be set.

Buffer Time

Sometimes you may experience uneven playback of the internet radio. This can happen if the internet connection is slow or network congestion occurs. To help improving the situation, you can choose longer buffer time to get a few seconds of radio stream before beginning to play. The default value is 2 seconds. You can choose 5 seconds if you prefer to have a longer buffering time.

Information

View the Network and System Information of your radio.

When you use your PC to manage the My favorite stations, you have to use the IP address and you can view this info from here. Then type in the IP address (Configuration > Information > Network Information > IP) to your PC's browser input window

Software Update

There may be software release to upgrade features of the radio from time to time. Check the update regularly to keep your radio up to date with the latest software.

Reset to Default

You can do the reset to clear all the settings and return to default settings.

** Please note all the Station presets, Settings and configuration will be erased after you have performed the Reset.

12. Remote control via PC / Smart phone - Tuning internet radio & manage favourites

Experience an easy way to control tuning internet radio channels and manage your favourite list via PC or Smart phone's web browser.

The supported browsers are Internet Explorer and Chrome. Have your radio stayed on the Internet radio mode when using this feature.

- Connect your PC or Smart phone to the same Wi-Fi network as your radio.
- Visit **www.skytune.net**
- On the home page, click "Browse/Search"

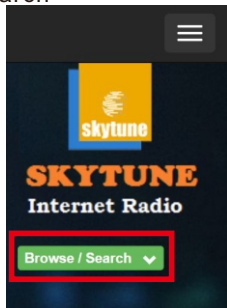

- Browse or enter the name to search the radio channel, a list of internet radio channels will be displayed.
- Click the "♥" symbol

Result for Searching 'dance'



1.fm 90's
Dance



1.fm Dance
One



101.RU - Club
Dance



101.RU -
Russian Dance



12. Remote control via PC / Smart phone - Tuning internet radio & manage favourites

- It will prompt you whether to "Add Favourite" or "Listen to Station". Enter the IP address of your radio (e.g. 192.168.1.11):

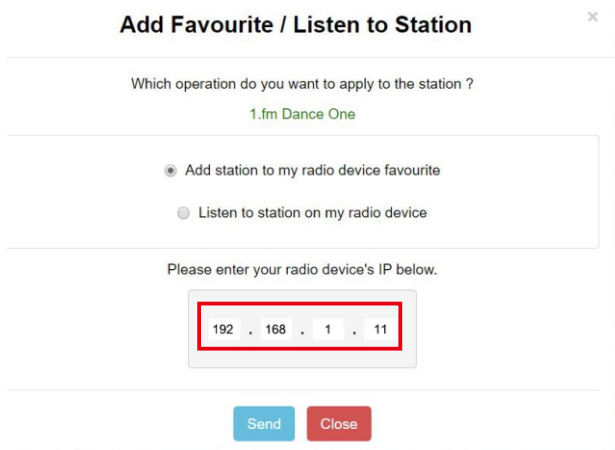

The screenshot shows a web browser window with the title "Add Favourite / Listen to Station" and a close button (X) in the top right corner. The main content area asks, "Which operation do you want to apply to the station ?" and displays "1.fm Dance One" in green text. Below this, there are two radio button options: "Add station to my radio device favourite" (which is selected) and "Listen to station on my radio device". Underneath, it says "Please enter your radio device's IP below." and shows a text input field containing "192 . 168 . 1 . 11", which is highlighted with a red rectangular border. At the bottom of the form, there are two buttons: a blue "Send" button and a red "Close" button.

The IP address is located on the radio unit as follow:

- * On the radio, return to the Home screen. Navigate to **Configuration > Information > Network Information > IP**

- Select "Listen to Station", click "Send" and the radio unit will switch playing the channel and the "My Favourite" page will pop up on the web browser. You can then choose to add the playing station to favourite or manage your list by other edit options. Any changes will synchronize to the radio unit immediately.

12. Remote control via PC / Smart phone

- Tuning internet radio & manage favourites

MY FAVOURITE

Channel Group : ROOT

	Channel Name	URL							
1.	DJ AAM Radio FM	*****	Edit	Delete	Top	Up	Down	Bottom	
2.	Country Radio Switzerlar	*****	Edit	Delete	Top	Up	Down	Bottom	
3.	Bigbeat	*****	Edit	Delete	Top	Up	Down	Bottom	
4.	24Radio Switzerland	*****	Edit	Delete	Top	Up	Down	Bottom	
5.	AFN American Freedom	*****	Edit	Delete	Top	Up	Down	Bottom	
6.	Energy Berlin	http://energyradio.de/bremen	Edit	Delete	Top	Up	Down	Bottom	
7.	MP3 Pro	http://www.katrafm.com/katrafm_mp3pro.m3u	Edit	Delete	Top	Up	Down	Bottom	
8.	2	http://www.ultranet.biz/vegasandanski.m3u	Edit	Delete	Top	Up	Down	Bottom	
9.	stream 2	http://lindowsradio.com:8600/listen.pls	Edit	Delete	Top	Up	Down	Bottom	
10.	aac 128	http://eastlondonradio.com:8100/bighigh.aac	Edit	Delete	Top	Up	Down	Bottom	
11.	Seoul Shoutcast	http://yp.shoutcast.com/sbin/tunein-station.	Edit	Delete	Top	Up	Down	Bottom	

Add Channel

Channel Name	URL		
<input type="text"/>	<input type="text"/>	Submit	Reset

You can also add the radio channel if you know the published audio stream URL with the streaming format as follow:

1. Audio formats: MP3, AAC, AAC+
2. Stream formats: Shoutcast, Icecast (HTTP, HTTPS) and HLS
3. Playlist formats: PLS, M3U
4. Sampling frequency: 44.1 KHz and 48 KHz

13. Trouble Shooting

Problem	Cause	Solutions
Cannot connect to Wi-Fi network	Network down	<ul style="list-style-type: none"> • Confirm that a Wi-Fi or Ethernet Wired connected PC can access the internet (i.e. can browse the web) using the same network. • Check that a DHCP server is available, or that you have configured a static IP address on the radio. • Check that you firewall is not blocking any outgoing ports. As a minimum the radio needs access to UDP and TCP ports 80,443 and 8008, DNS port 53.
	Router restricts access to listed MAC addresses	<p>Obtain the MAC address from Configuration > Information > Network > Wi-Fi MAC and add to the allowed equipment list on your access point.</p> <p>Note: The radio has separate MAC addresses for wireless networks.</p>
	Insufficient Wi-Fi signal strength	<ul style="list-style-type: none"> • Check distance to router; see if a computer can connect to the network in this location • Optimize the distance of the router's location
	Unknown encryption method	<p>Change encryption method on router.</p> <p>The radio supports WEP, WPA, WPA2</p>
	Firewall preventing access	<p>Disable the fire wall to see if radio can connect to the network.</p> <p>Windows Media Player: varies — non-Microsoft firewalls may require configuration for UPnP.</p>

13. Trouble Shooting

Problem	Cause	Solutions
If your radio can connect to the network successfully, but is unable to play particular stations		<ul style="list-style-type: none"> • The station is not broadcasting at this time of the day (remember it may be located in a different time zone). • The station has too many people trying to attach to the radio station server and the server capacity is not large enough. • The station has reached the maximum allowed number of simultaneous listeners. • The link on the radio is out of date. The update of the link is done regularly. To get the updated list of stations, please access from Internet radio > Skytune. In case a particular stream is still not working, please contact us or report the case to Skytune.
No DAB/FM reception		<ul style="list-style-type: none"> • Please carry out "Reset to default" on the radio and extend the antenna. • Move the radio closer to the window.
DAB/FM Radio reception is poor		<ul style="list-style-type: none"> • Please check that the aerial is extended for the maximum signal strength and adjust the direction to improve reception. • Check that you do not have other electrical equipment too close to your radio, causing interference.
No sound		<ul style="list-style-type: none"> • Please check whether the playback is stopped. Press the OK button to resume playback. • Adjust the volume • Check if other radio stations have the same problem or just happened on a particular station.
Radio got freeze or no response		Carry out a reset as follow: On the radio unit, press the ⏏ and OK buttons together until the radio is off (screen is blank), then release both buttons.

1. If the Internet Radio keeps re-buffering radio station:

The Internet Radio is streaming the data from the radio station via your broadband connection, if there is a high error rate on your broadband connection, or the connection is intermittent, then it will cause the Internet Radio to pause until the connection is re-established and it has received enough data to start playing again.

If your Internet Radio keeps stopping, please check the DSL modem to ensure that the Broadband line is not suffering a high error rate or disconnections. If you are experiencing these problems, you will need to contact your broadband supplier.

2. What is Buffering?

When playing a stream, the Internet Radio/Media player, downloads a small amount of the stream before it starts playing. This is used to fill in any gaps in the stream that may occur if the internet or the wireless network is busy. The Internet Radio streams music data from the PC while you are listening. If a stream gets blocked or experiences Internet congestion while transferring it may stop/interfere with the quality of play. If this happens, check your internet connection speed- it must be faster than the speed of the streams.

Helpful Tips

3. My radio is working but some stations cannot be played.

The problem may be due to one or more of the followings:

- a. The radio station is no longer broadcasting.
- b. The radio station has reached the maximum allowed number of simultaneous listeners.
- c. The radio station has changed the stream arrangement and the link is no longer valid.
- d. The radio station is not broadcasting at the time of the day (not all stations are broadcasting 24 hours throughout the day).
- e. The Internet connection between your radio and the radio station server is too slow or unstable to support the data rate of the broadcast.

Technical Specification

Model	WR-23D
Power input	5V  1A
Power voltage	100-240V~50/60Hz
Wireless Network	IEEE802.11b/g/n
Wireless network frequency	2412 - 2484 MHZ
Wireless transmission power	Typical transmission power 14 dBm (72.2 Mbps); 20 dBm (11b mode)
Security Protocol	WEP/WPA/WPA2
Bluetooth version	V4.2 BR/EDR compliant
Bluetooth frequency	2.4 GHz
Bluetooth range	10 meters (line of sight)
DAB frequency range	174.928MHz (5A) - 239.200MHz (13F) Support DAB and DAB+
FM frequency range	87.5-108MHz
Built-in Lithium-ion battery	3.7V, 2000 mAh
Audio output	Stereo earphone jack 3.5 mm
Telescopic antenna	
Unit Dimension	160 x 41 x 91 mm (L x D x H)

Remark: Specification may vary without notice

In the box

- * Internet Radio
- * USB cable
- * User manual

WEEE and Recycling



The European laws do not allow any more the disposal of old or defective electric or electronic devices with the household waste. Return your product to a municipal collection point for recycling to dispose of it. This system is financed by the industry and ensures environmentally responsible disposal and the recycling of valuable raw materials.

Ocean Digital Technology Ltd.
Flat B, 12/F., Yeung Yiu Chung (No.8) Ind. Bldg.,
20 Wang Hoi Road, Kowloon Bay,
Hong Kong
Email: support@oceandigital.com.hk